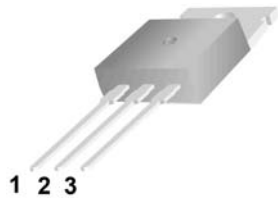
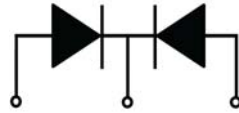

<p>MUR2005CT-MUR2060CT</p> <p>Features:</p> <ul style="list-style-type: none"> <input type="checkbox"/> High surge capacity <input type="checkbox"/> Low Forward Voltage Drop. <input type="checkbox"/> High Current Capability. <input type="checkbox"/> Super Fast Switching Speed For High Efficiency 	<div style="text-align: right;">  </div> <p style="text-align: center;">TO-220</p>   <p style="text-align: center;">1.Anode 2.Cathode 3. Anode</p>
--	---

Absolute Maximum Ratings (Ta=25°C unless otherwise noted)

Parameter	Symbol	MUR 2005CT	MUR 2010CT	MUR 2015CT	MUR 2020CT	MUR 2030CT	MUR 2040CT	MUR 2060CT	Unit
Maximum recurrent peak reverse voltage	V _{RRM}	50	100	150	200	300	400	600	V
Maximum RMS Voltage	V _{RMS}	35	70	105	140	210	280	420	V
Maximum DC Blocking Voltage	V _{R(DC)}	50	100	150	200	300	400	600	V
Average Rectified Forward Current Total Device, (Rated V _R),	I _{F(AV)}	20							A
Nonrepetitive Peak Surge Current(Surge applied at rated load conditions half wave, single phase, 60 Hz)	I _{FSM}	200							A
Operating Junction Temperature and Storage Temperature	T _J , T _{stg}	-55 to +155							°C
Maximum Thermal Resistance, Junction-to-Case	R _{θJC}	3.0				2.0			°C/W

ELECTRICAL CHARACTERISTICS

Parameter	Symbol	MUR 2005CT	MUR 2010CT	MUR 2015CT	MUR 2020CT	MUR 2030CT	MUR 2040CT	MUR 2060CT	Unit
Forward Voltage (I _F =20A, T _C = 25°C) (Note 1) (I _F =20 A, T _C = 125°C)	V _F	0.975 0.895			1.30 1.10		1.70 1.50		V
Maximum Instantaneous Reverse Current (Note 1) (Rated DC Voltage, T _C = 25°C) (Rated DC Voltage, T _C = 125°C)	I _R	5 250			10 500			μA	
Maximum Reverse Recovery Time (I _F = 0.5 A, I _R = 1.0 A, I _{REC} = 0.25 A)	T _{RR}	35							ns

Note 1.Pulse Test: Pulse Width = 300 μs, Duty Cycle ≤2.0%

Typical Characteristics

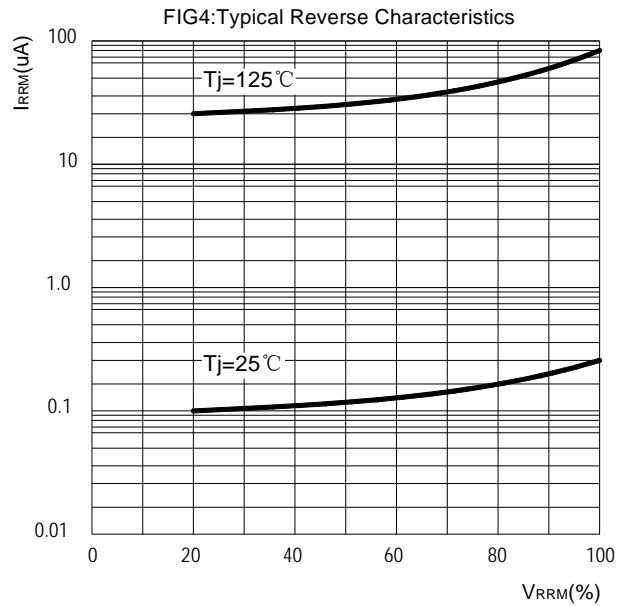
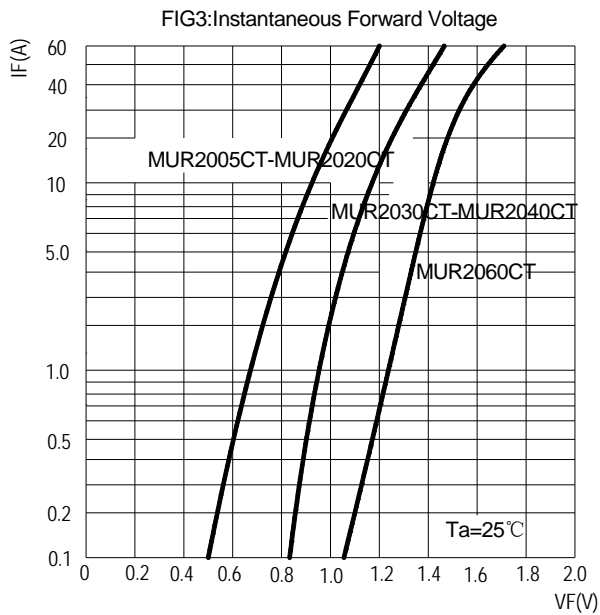
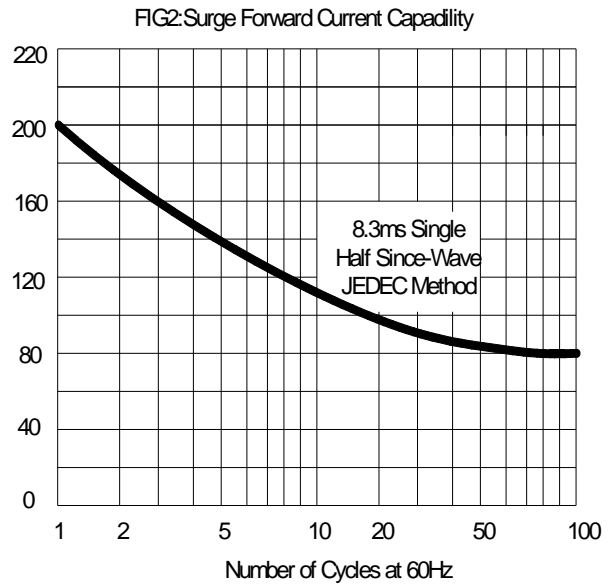
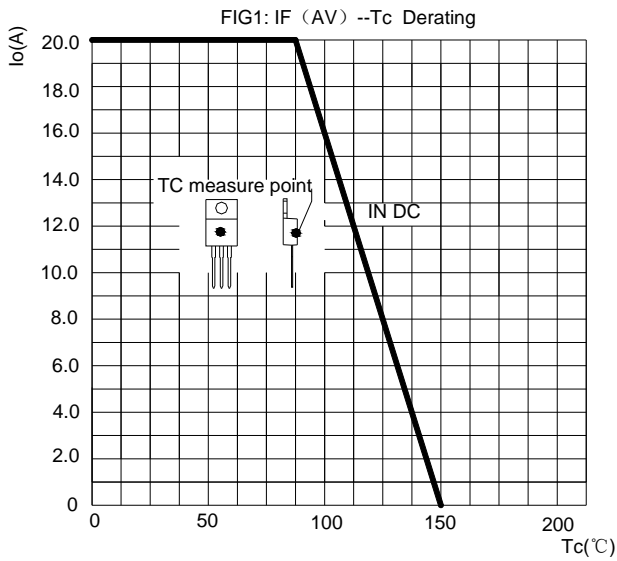
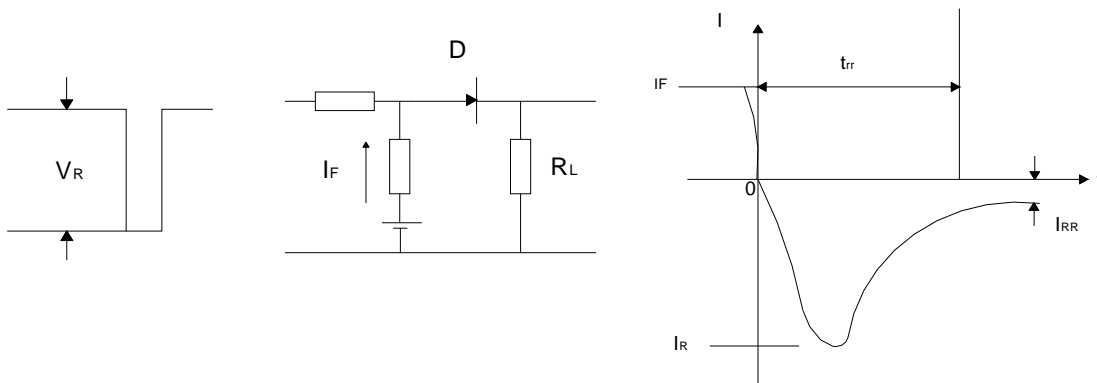

FIG.5: Diagram of circuit and Testing wave form of reverse recovery time



Package Dimension

模具1

TO-220

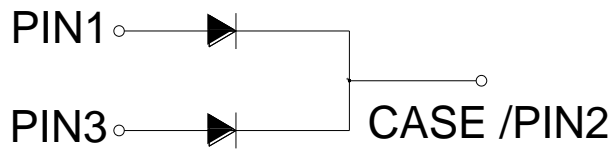
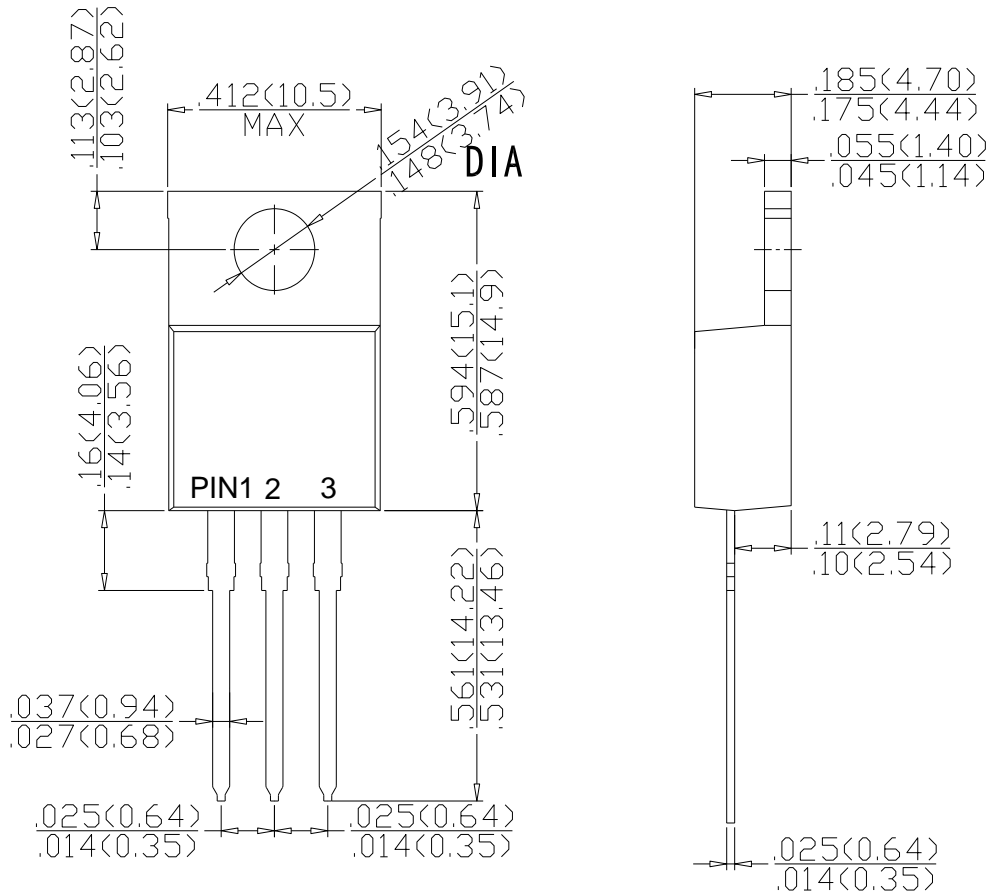

Dimensions in inches and (millimeters)