

- ★ Green Device Available
- ★ Super Low Gate Charge
- ★ Excellent CdV/dt effect decline
- ★ Advanced high cell density Trench technology



Product Summary

BVDSS	RDSON	ID
-30V	28mΩ	-6.0A

Description

The XXW30P06 is the high cell density trenched N-ch MOSFETs, which provides excellent RDSON and efficiency for most of the small power switching and load switch applications.

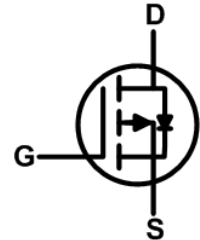
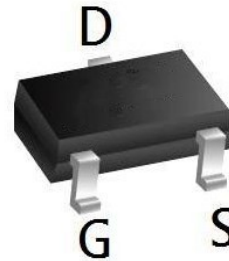
The XXW30P06 meet the RoHS and Green Product requirement with full function reliability approved.

SOT23 Pin Configuration

Absolute Maximum Ratings ($T_A=25^{\circ}\text{C}$ unless otherwise specified)

Symbol	Parameter	Max.	Units	
V_{DSS}	Drain-Source Voltage	-30	V	
V_{GSS}	Gate-Source Voltage	± 20	V	
I_D	Continuous Drain Current	$T_A = 25^{\circ}\text{C}$	-6	A
		$T_A = 100^{\circ}\text{C}$	-4.6	A
I_{DM}	Pulsed Drain Current ^{note1}	-18	A	
P_D	Power Dissipation	$T_A = 25^{\circ}\text{C}$	1.5	W
$R_{\theta JA}$	Thermal Resistance, Junction to Ambient	61.7	$^{\circ}\text{C}/\text{W}$	
T_J, T_{STG}	Operating and Storage Temperature Range	-55 to +150	$^{\circ}\text{C}$	

Electrical Characteristics ($T_J=25^{\circ}\text{C}$ unless otherwise specified)

Symbol	Parameter	Test Condition	Min.	Typ.	Max.	Units
Off Characteristic						
$V_{(BR)DSS}$	Drain-Source Breakdown Voltage	$V_{GS}=0V, I_D=-250\mu A$	-30	-	-	V
I_{DSS}	Zero Gate Voltage Drain Current	$V_{DS}=-30V, V_{GS}=0V,$	-	-	-1	μA
I_{GSS}	Gate to Body Leakage Current	$V_{DS}=0V, V_{GS}=\pm 20V$	-	-	± 100	nA
On Characteristics						
$V_{GS(th)}$	Gate Threshold Voltage	$V_{DS}=V_{GS}, I_D=-250\mu A$	-1.0	-1.5	-2.5	V
$R_{DS(on)}$	Static Drain-Source on-Resistance <small>note3</small>	$V_{GS}=-10V, I_D=-7A$	-	28	37	m Ω
		$V_{GS}=-4.5V, I_D=-4A$	-	34	54	
Dynamic Characteristics						
C_{iss}	Input Capacitance	$V_{DS}=-15V, V_{GS}=0V,$ $f=1.0MHz$	-	982	-	pF
C_{oss}	Output Capacitance		-	135	-	pF
C_{rss}	Reverse Transfer Capacitance		-	109	-	pF
Q_g	Total Gate Charge	$V_{DS}=-15V, I_D=-4A,$ $V_{GS}=-10V$	-	10	-	nC
Q_{gs}	Gate-Source Charge		-	2	-	nC
Q_{gd}	Gate-Drain("Miller") Charge		-	2.7	-	nC
Switching Characteristics						
$t_{d(on)}$	Turn-on Delay Time	$V_{DD}=-15V, I_D=-7A,$ $V_{GS}=-10V, R_{GEN}=2.5\Omega$	-	11	-	ns
t_r	Turn-on Rise Time		-	19	-	ns
$t_{d(off)}$	Turn-off Delay Time		-	45	-	ns
t_f	Turn-off Fall Time		-	26	-	ns
Drain-Source Diode Characteristics and Maximum Ratings						
I_S	Maximum Continuous Drain to Source Diode Forward Current		-	-	-6	A
I_{SM}	Maximum Pulsed Drain to Source Diode Forward Current		-	-	-28	A
V_{SD}	Drain to Source Diode Forward Voltage	$V_{GS}=0V, I_S=-7A$	-	-0.8	-1.2	V

Notes:1. Repetitive Rating: Pulse Width Limited by Maximum Junction Temperature

 2. Pulse Test: Pulse Width $\leq 300\mu s$, Duty Cycle $\leq 2\%$

Typical Performance Characteristics

Figure 1: Output Characteristics

Figure 2: Typical Transfer Characteristics

Figure 3: On-resistance vs. Drain Current

Figure 4: Body Diode Characteristics

Figure 5: Gate Charge Characteristics

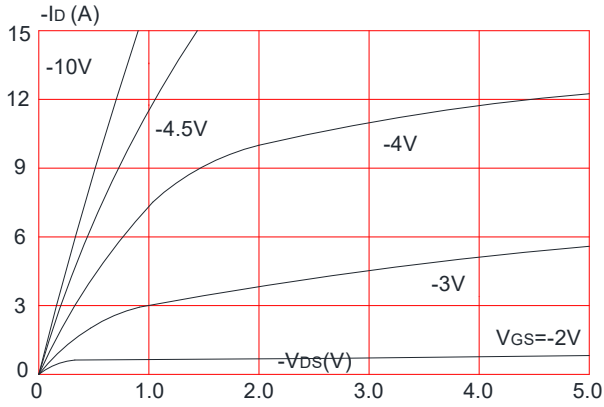
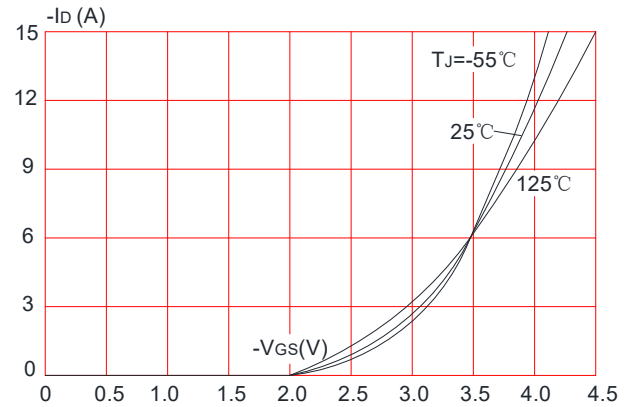
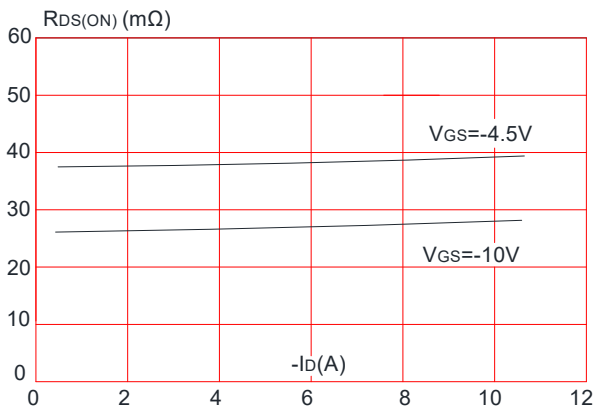
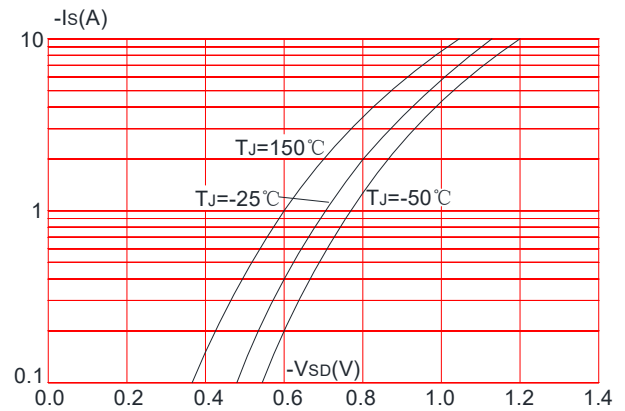
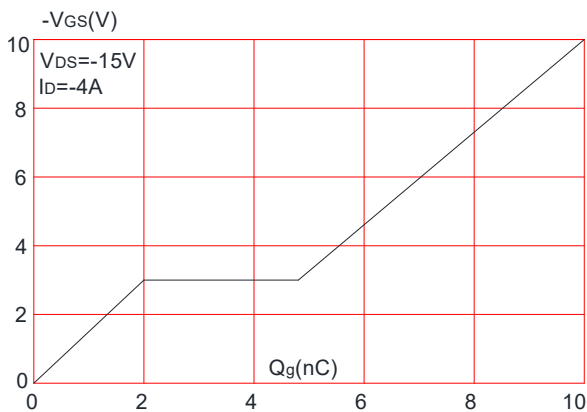
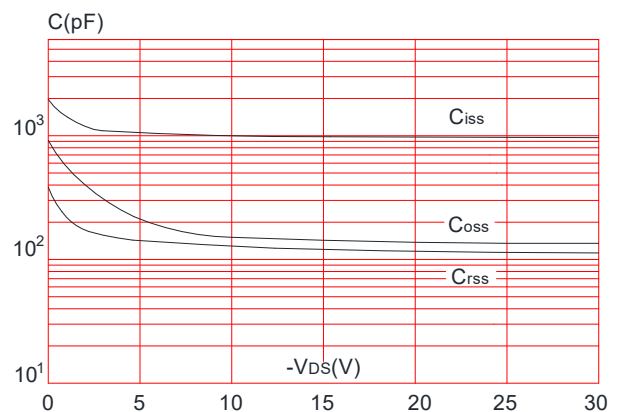
Figure 6: Capacitance Characteristics

Figure 7: Normalized Breakdown Voltage vs. Junction Temperature

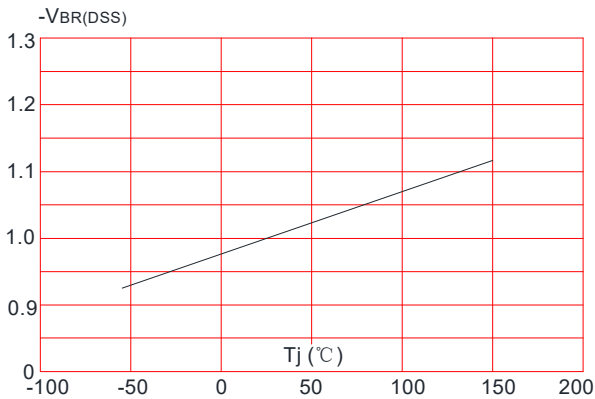

Figure 8: Normalized on Resistance vs. Junction Temperature

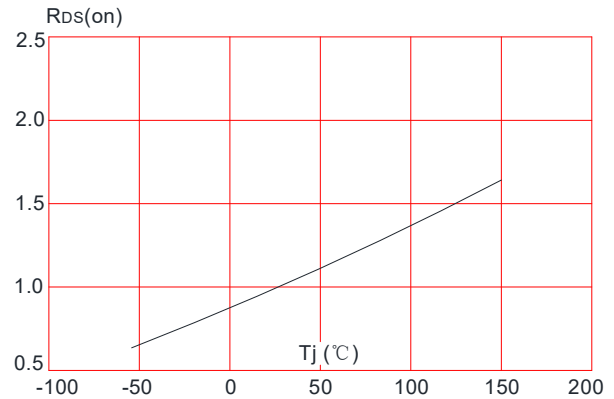

Figure 9: Maximum Safe Operating Area

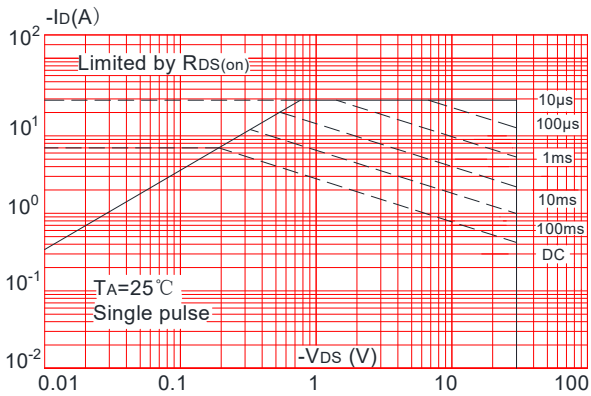
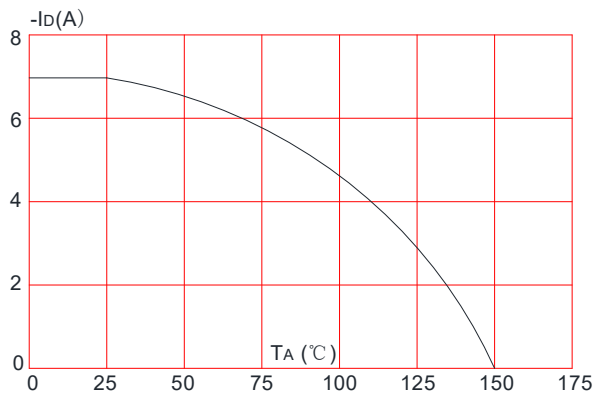
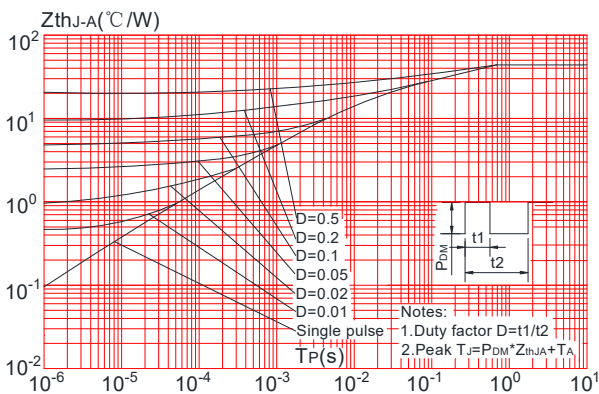
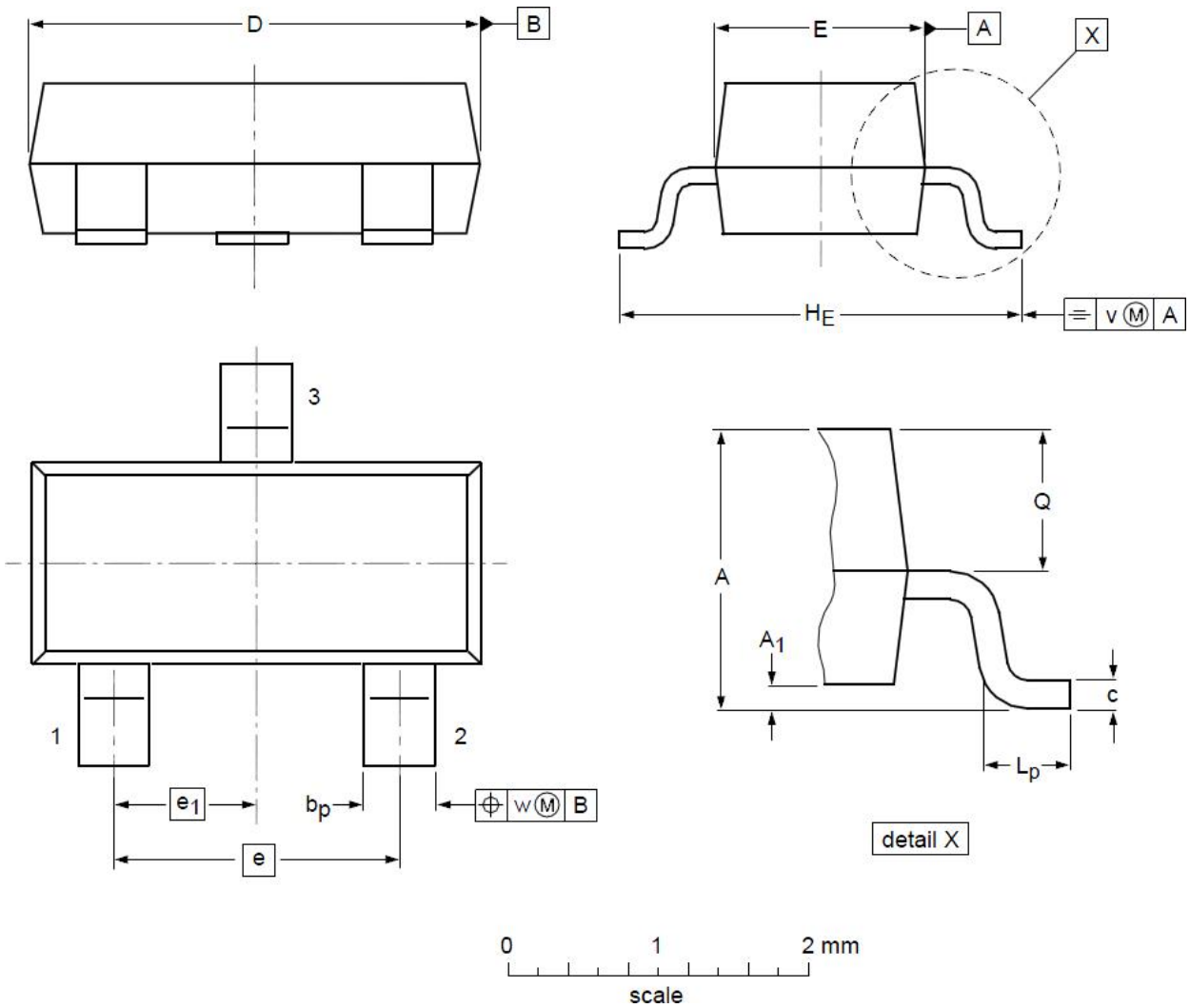

Figure 10: Maximum Continuous Drain Current vs. Ambient Temperature



Maximum Effective Transient Thermal Impedance, Junction-to-Ambient



Package Mechanical Data-SOT-23

DIMENSIONS (unit : mm)

Symbol	Min	Typ	Max	Symbol	Min	Typ	Max
A	0.90	1.01	1.15	A ₁	0.01	0.05	0.10
b _p	0.30	0.42	0.50	c	0.08	0.13	0.15
D	2.80	2.92	3.00	E	1.20	1.33	1.40
e	--	1.90	--	e ₁	--	0.95	--
H _E	2.25	2.40	2.55	L _p	0.30	0.42	0.50
Q	0.45	0.49	0.55	v	--	0.20	--
w	--	0.10	--				