

- ★ Super Low Gate Charge
- ★ Green Device Available
- ★ Excellent CdV/dt effect decline
- ★ Advanced high cell density Trench technology

**Product Summary**

BVDSS	RDSON	ID
-20V	10mΩ	-30A

**Description**

The XXW30P02D is the high cell density trenched P-ch MOSFETs, which provide excellent RDSON and gate charge for most of the synchronous buck converter applications. The XXW30P02D meet the RoHS and Green Product requirement with full function reliability approved.

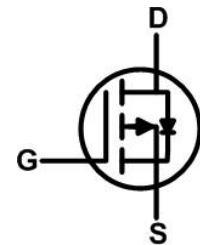
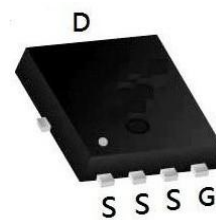
**PDFN3333-8L Pin Configuration**

**Absolute Maximum Ratings**

Symbol	Parameter	Rating	Units
$V_{DS}$	Drain-Source Voltage	-20	V
$V_{GS}$	Gate-Source Voltage	$\pm 12$	V
$I_D@T_C=25^\circ C$	Continuous Drain Current, $V_{GS} @ -4.5V^1$	-30	A
$I_D@T_C=70^\circ C$	Continuous Drain Current, $V_{GS} @ -4.5V^1$	-18	A
$I_{DM}$	Pulsed Drain Current <sup>2</sup>	-68	A
$P_D@T_C=25^\circ C$	Total Power Dissipation <sup>3</sup>	18	W
$P_D@T_C=70^\circ C$	Total Power Dissipation <sup>3</sup>	12	W
$T_{STG}$	Storage Temperature Range	-55 to 150	$^\circ C$
$T_J$	Operating Junction Temperature Range	-55 to 150	$^\circ C$

**Thermal Data**

Symbol	Parameter	Max.	Unit
$R_{\theta JA}$	Thermal Resistance Junction-Ambient <sup>1</sup>	75	$^\circ C/W$
$R_{\theta JA}$	Thermal Resistance Junction-Ambient <sup>1</sup> ( $t \leq 10s$ )	40	$^\circ C/W$
$R_{\theta JC}$	Thermal Resistance Junction-Case <sup>1</sup>	4.2	$^\circ C/W$

**Electrical Characteristics ( $T_J=25^\circ\text{C}$ , unless otherwise noted)**

Symbol	Parameter	Conditions	Min.	Typ.	Max.	Unit
$BV_{DSS}$	Drain-Source Breakdown Voltage	$V_{GS}=0V, I_D=-250\mu A$	-20	---	---	V
$\Delta BV_{DSS}/\Delta T_J$	$BV_{DSS}$ Temperature Coefficient	Reference to $25^\circ\text{C}$ , $I_D=-1\text{mA}$	---	-0.012	---	$V/^\circ\text{C}$
$R_{DS(ON)}$	Static Drain-Source On-Resistance <sup>2</sup>	$V_{GS}=-4.5V, I_D=-10A$	---	10	15	m $\Omega$
		$V_{GS}=-2.5V, I_D=-8A$	---	13	18	
$V_{GS(th)}$	Gate Threshold Voltage	$V_{GS}=V_{DS}, I_D=-250\mu A$	-0.4	-0.7	-1.0	V
$\Delta V_{GS(th)}$	$V_{GS(th)}$ Temperature Coefficient		---	2.94	---	$\text{mV}/^\circ\text{C}$
$I_{DSS}$	Drain-Source Leakage Current	$V_{DS}=-15V, V_{GS}=0V, T_J=25^\circ\text{C}$	---	---	1	$\mu A$
$I_{GSS}$	Gate-Source Leakage Current	$V_{GS}=\pm 12V, V_{DS}=0V$	---	---	$\pm 100$	nA
gfs	Forward Transconductance	$V_{DS}=-5V, I_D=-10A$	---	43	---	S
$Q_g$	Total Gate Charge (-4.5V)	$V_{DS}=-10V, V_{GS}=-4.5V, I_D=-10A$	---	35	---	nC
$Q_{gs}$	Gate-Source Charge		---	5.0	---	
$Q_{gd}$	Gate-Drain Charge		---	10	---	
$T_{d(on)}$	Turn-On Delay Time	$V_{DD}=-10V, V_{GS}=-4.5V,$ $R_G=3.3\Omega, I_D=-10A$	---	12.0	---	ns
$T_r$	Rise Time		---	40.0	---	
$T_{d(off)}$	Turn-Off Delay Time		---	30	---	
$T_f$	Fall Time		---	10	---	
$C_{iss}$	Input Capacitance	$V_{DS}=-15V, V_{GS}=0V, f=1\text{MHz}$	---	2800	---	pF
$C_{oss}$	Output Capacitance		---	690	---	
$C_{rss}$	Reverse Transfer Capacitance		---	590	---	

**Diode Characteristics**

Symbol	Parameter	Conditions	Min.	Typ.	Max.	Unit
$I_S$	Continuous Source Current <sup>1,4</sup>	$V_G=V_D=0V$ , Force Current	---	---	-30.0	A
$I_{SM}$	Pulsed Source Current <sup>2,4</sup>		---	---	---	A
$V_{SD}$	Diode Forward Voltage <sup>2</sup>	$V_{GS}=0V, I_S=-1A, T_J=25^\circ\text{C}$	---	---	-1.2	V
$t_{rr}$	Reverse Recovery Time	$I_F=-10A, dI/dt=100A/\mu s,$ $T_J=25^\circ\text{C}$	---	27	---	nS
$Q_{rr}$	Reverse Recovery Charge		---	17.8	---	nC

Note :

1. The data tested by surface mounted on a 1 inch<sup>2</sup> FR-4 board with 2OZ copper.
2. The data tested by pulsed, pulse width  $\leq 300\mu s$ , duty cycle  $\leq 2\%$
3. The power dissipation is limited by  $150^\circ\text{C}$  junction temperature
4. The data is theoretically the same as  $I_D$  and  $I_{DM}$ , in real applications, should be limited by total power dissipation.

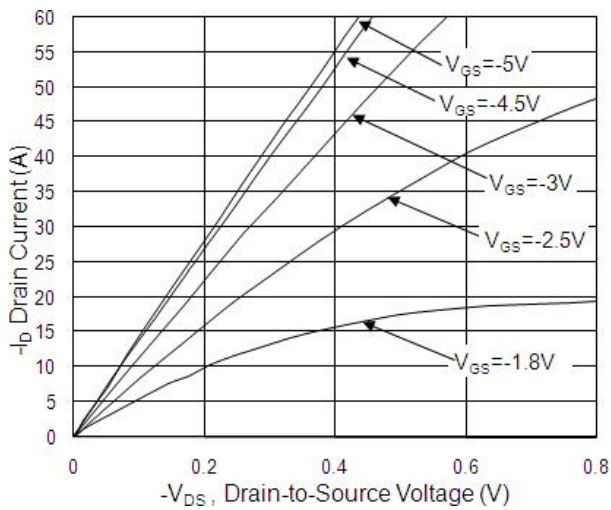
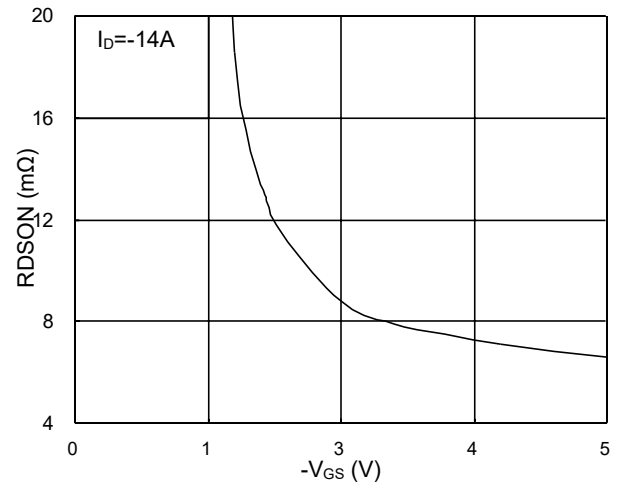
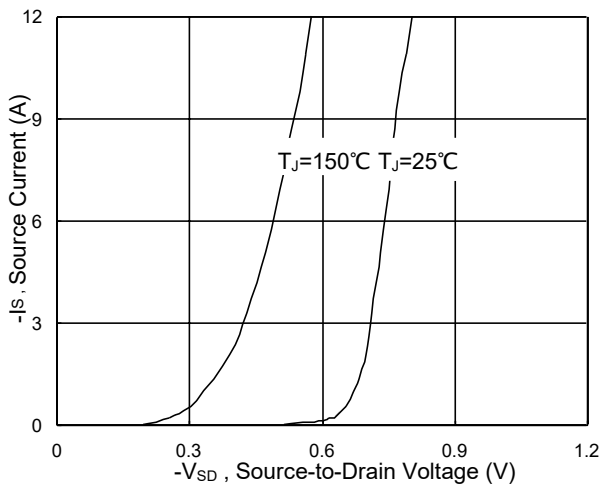
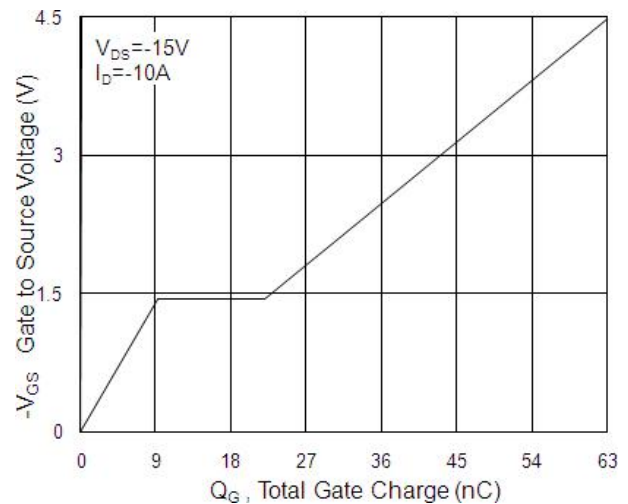
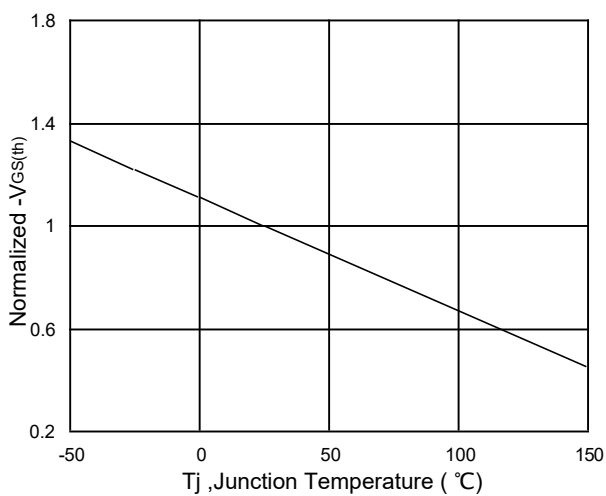
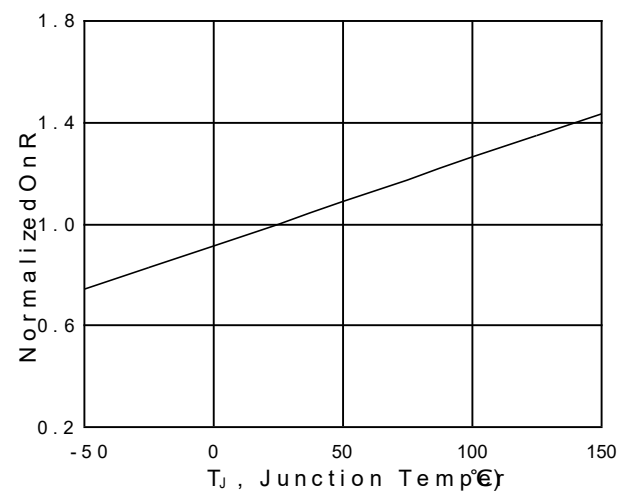
**Typical Characteristics**

**Fig.1 Typical Output Characteristics**

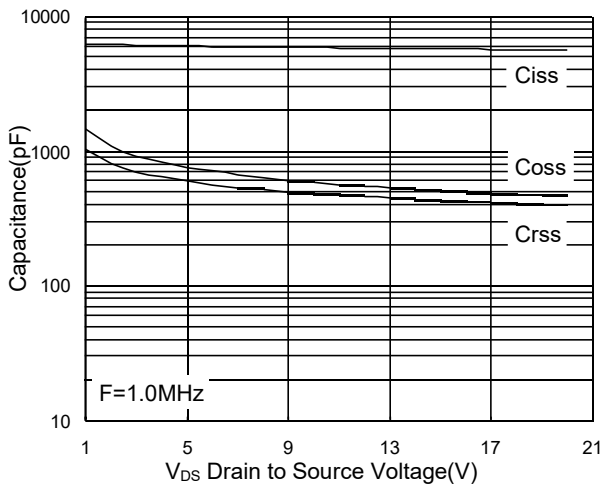
**Fig.2 On-Resistance vs. G-S Voltage**

**Fig.3 Forward Characteristics of Reverse**

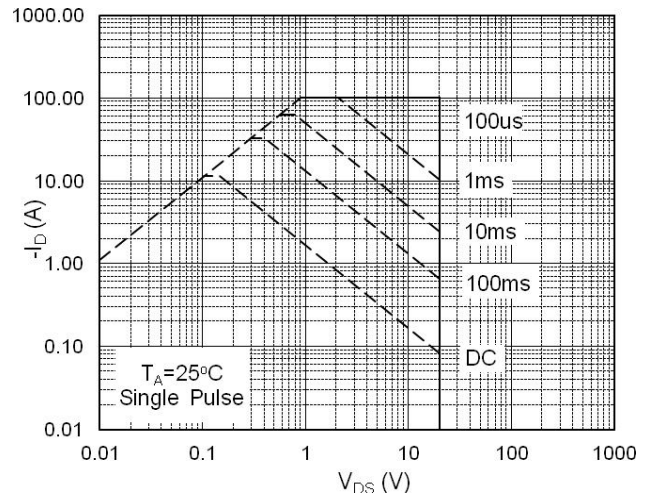
**Fig.4 Gate-charge Characteristics**

**Fig.5 Normalized  $V_{GS(th)}$  vs.  $T_J$** 

**Fig.6 Normalized  $R_{DS(on)}$  vs.  $T_J$**

**P-Ch 20V Fast Switching MOSFETs**



**Fig.7 Capacitance**



**Fig.8 Safe Operating Area**

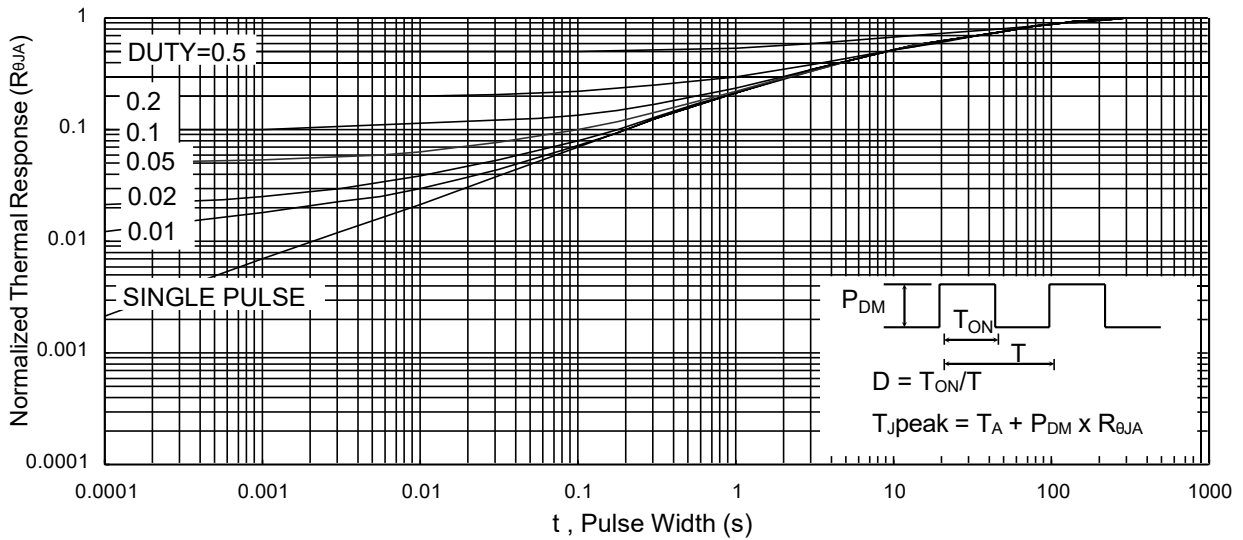

**Fig.9 Normalized Maximum Transient Thermal Impedance**

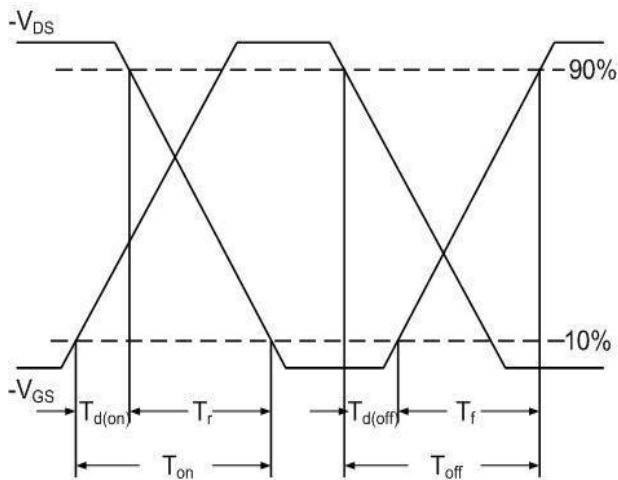

**Fig.10 Switching Time Waveform**

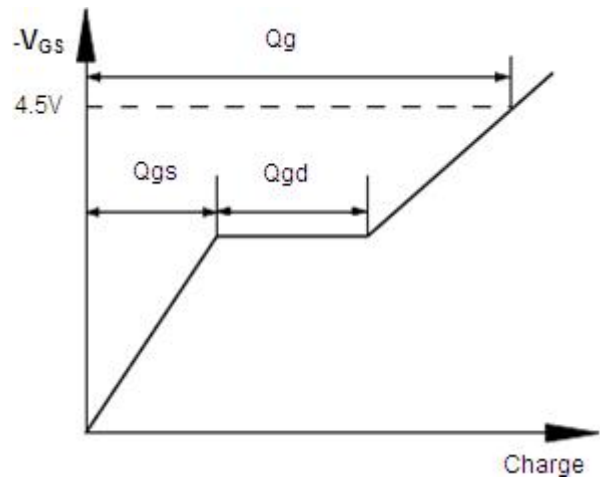

**Fig.11 Gate Charge Waveform**

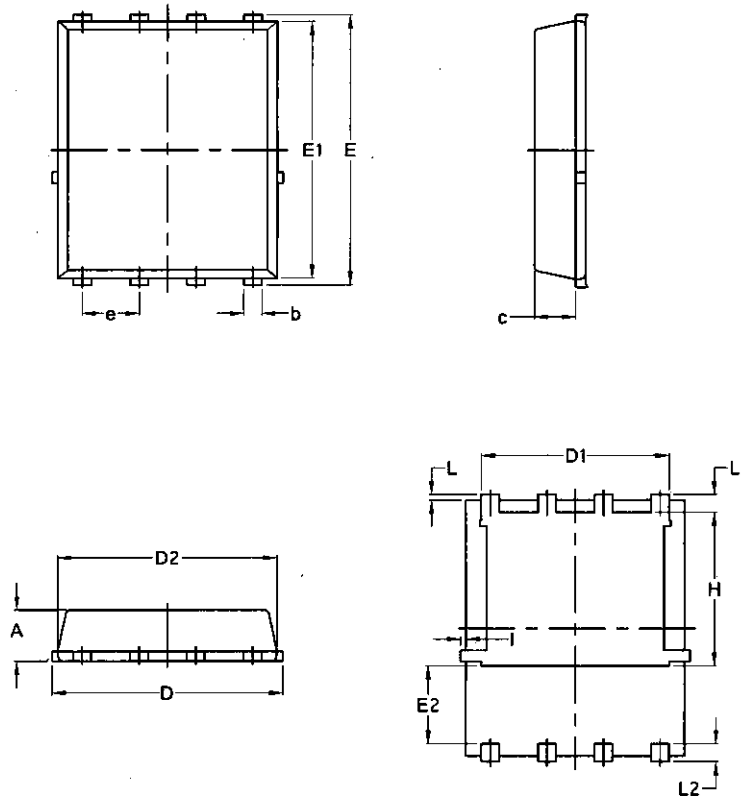
**Package Mechanical Data-PDFN3333-8L-Single**

**COMMON DIMENSIONS**

(UNITS OF MEASURE=MILLIMETER)

SYMBOL	MIN	NOM	MAX
A	0.70	0.80	0.90
A1	0.00	0.03	0.05
b	0.24	0.30	0.35
c	0.10	0.15	0.20
D	3.25	3.32	3.40
D1	3.05	3.15	3.25
D2	2.40	2.50	2.60
E	3.00	3.10	3.20
E1	1.35	1.45	1.55
e	0.65 BSC.		
H	3.20	3.30	3.40
L	0.30	0.40	0.50
L1	0.10	0.15	0.20
L2	1.13 REF.		